

**MODEL No:** J-SC1300

**Description:** 1300 mAh SIZE NI-MH SC

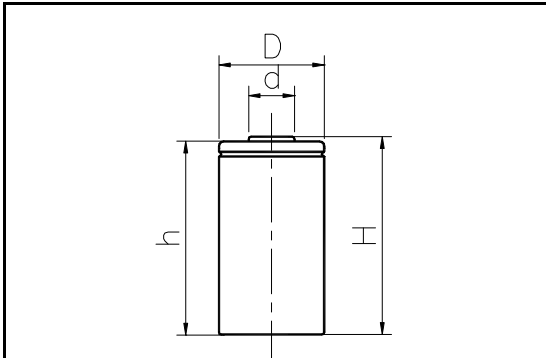

Dimensions(without Tube) (mm)

D	22.00±0.10
d	10.00±0.08
H	42.00±0.50
h	41.50±0.50

**Specification**

Nominal Capacity		1300 mAh
Nominal Voltage		1.2 V
Charge current	Standard	130 mA
	Fast	1300 mA
Charge time	Standard	16 Hrs
	Fast	1.2 Hrs
Ambient Temperature	Charge	Standard 0°C~45°C Fast 10°C~45°C
	Discharge	-20°C~60°C
	Storage	-20°C~55°C
Internal Impedance(mΩ) (After Charge)		≤ 20
Weight		37.0 g

