

MODEL No: D9000

Description: 9000 mAh SIZE NI-MH D

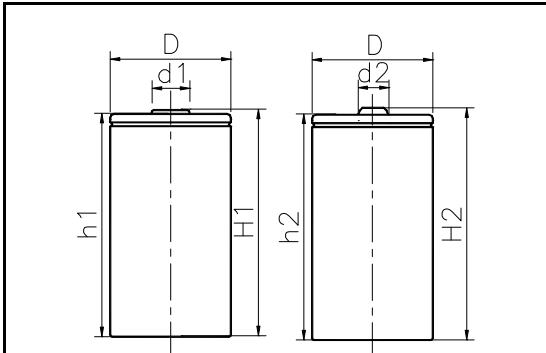

Dimensions(without Tube) (mm)

D	32.10±0.10		
d ₁	10.00±0.08	d ₂	8.00±0.08
H ₁	59.00±0.50	H ₂	60.50±0.50
h ₁	58.50±0.50	h ₂	58.50±0.50

Specification

Nominal Capacity		9000 mAh
Nominal Voltage		1.2 V
Charge current	Standard	900 mA
	Fast	2700 mA
Charge time	Standard	16 Hrs
	Fast	4 Hrs
Ambient Temperature	Charge	Standard 0°C~45°C Fast 10°C~45°C
	Discharge	-20°C~60°C
	Storage	-20°C~55°C
Internal Impedance(mΩ) (After Charge)		≤ 9
Weight		161.0 g

