

MODEL No: J-C4000

Description: 4000 mAh SIZE NI-MH C

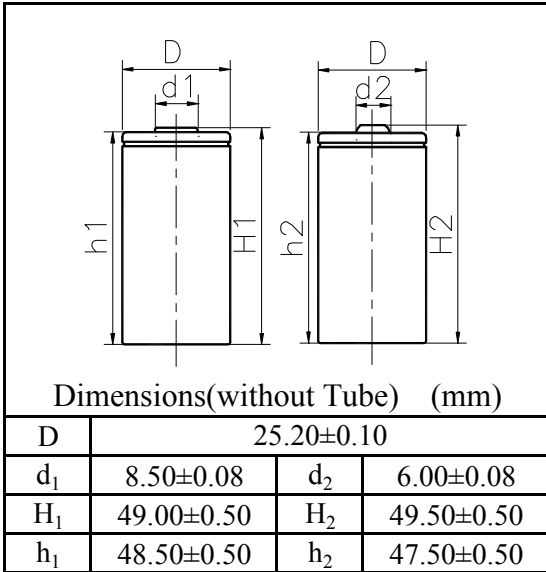

Specification

Nominal Capacity		4000 mAh
Nominal Voltage		1.2 V
Charge current	Standard	400 mA
	Fast	2000 mA
Charge time	Standard	16 Hrs
	Fast	2.4 Hrs
Ambient Temperature	Charge	Standard 0°C~45°C Fast 10°C~45°C
	Discharge	-20°C~60°C
	Storage	-20°C~55°C
Internal Impedance(mΩ) (After Charge)		≤ 12
Weight		82.0 g

