

MODEL No: J-C3700

Description: 3700 mAh SIZE NI-MH C

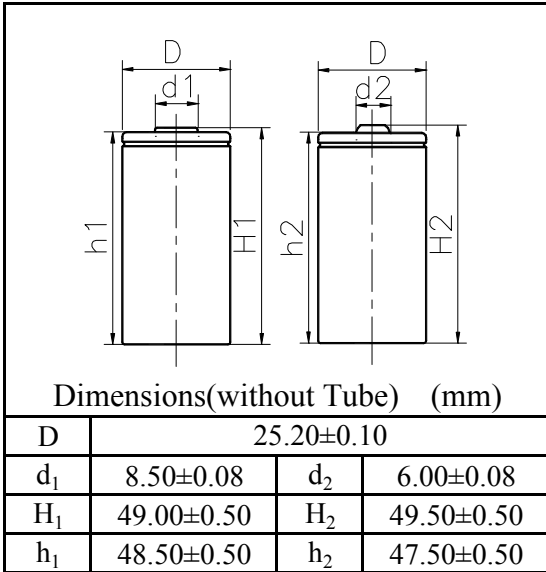

Specification

Nominal Capacity		3700 mAh
Nominal Voltage		1.2 V
Charge current	Standard	370 mA
	Fast	1850 mA
Charge time	Standard	16 Hrs
	Fast	2.4 Hrs
Ambient Temperature	Charge	Standard 0°C~45°C Fast 10°C~45°C
	Discharge	-20°C~60°C
	Storage	-20°C~55°C
Internal Impedance(mΩ) (After Charge)		≤ 11
Weight		78.0 g

