

MODEL No: J-AAA350

Description: 350 mAh SIZE NI-MH AAA

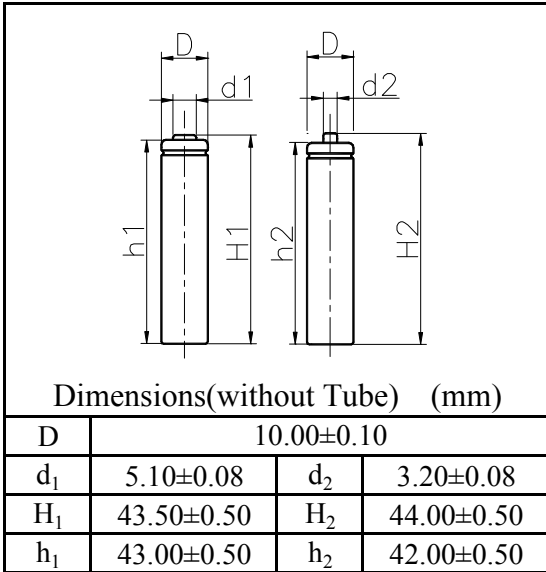

Specification

Nominal Capacity		350 mAh	
Nominal Voltage		1.2 V	
Charge current	Standard	35 mA	
	Fast	350 mA	
Charge time	Standard	16 Hrs	
	Fast	1.2 Hrs	
Ambient Temperature	Charge	Standard	0°C~45°C
		Fast	10°C~45°C
	Discharge		-20°C~60°C
Storage		-20°C~55°C	
Internal Impedance(mΩ) (After Charge)		≤ 50	
Weight		8.8 g	

