

MODEL No: J-AA900

Description: 900 mAh SIZE NI-MH AA

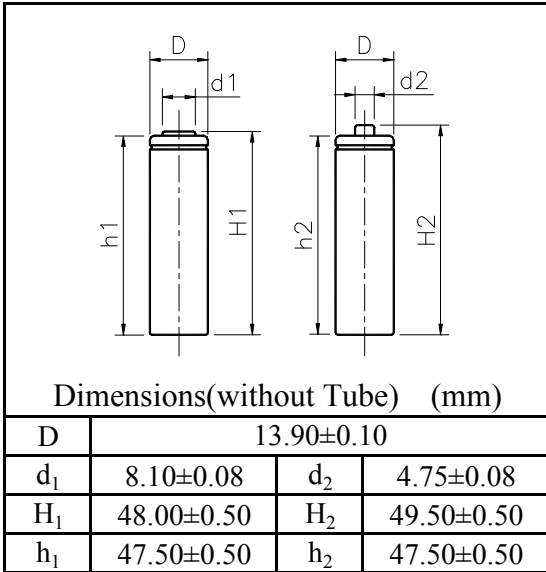

Specification

Nominal Capacity		900 mAh	
Nominal Voltage		1.2 V	
Charge current	Standard	90 mA	
	Fast	900 mA	
Charge time	Standard	16 Hrs	
	Fast	1.2 Hrs	
Ambient Temperature	Charge	Standard	0°C~45°C
		Fast	10°C~45°C
	Discharge		-20°C~60°C
Storage		-20°C~55°C	
Internal Impedance(mΩ) (After Charge)		≤ 28	
Weight		19.0 g	

