

MODEL No: J-AA800

Description: 800 mAh SIZE NI-MH AA

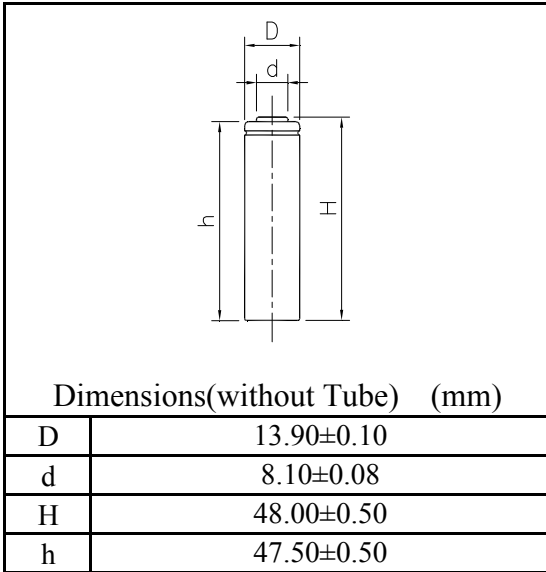

Specification

Nominal Capacity		800 mAh
Nominal Voltage		1.2 V
Charge current	Standard	80 mA
	Fast	800 mA
Charge time	Standard	16 Hrs
	Fast	1.2 Hrs
Ambient Temperature	Charge	Standard 0°C~45°C Fast 10°C~45°C
	Discharge	-20°C~60°C
	Storage	-20°C~55°C
Internal Impedance(mΩ) (After Charge)		≤ 28
Weight		18.0 g

