

MODEL No: 1/2A700

Description: 700 mAh SIZE NI-Cd A

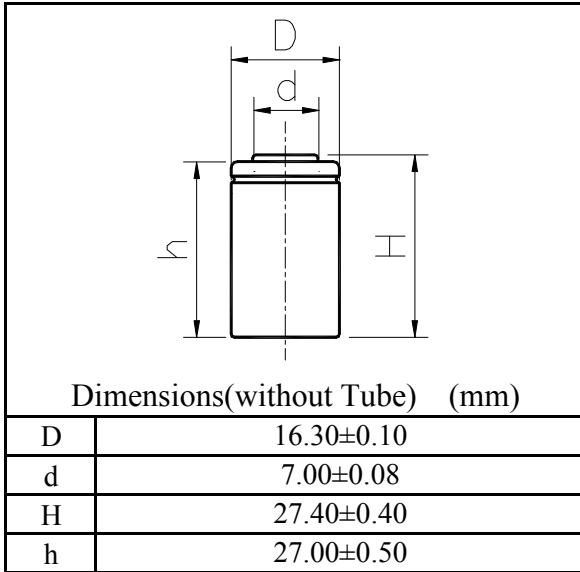

Specification

Nominal Capacity		700 mAh	
Nominal Voltage		1.2 V	
Charge current	Standard	70 mA	
	Fast	700 mA	
Charge time	Standard	16 Hrs	
	Fast	1.2 Hrs	
Ambient Temperature	Charge	Standard	0°C~45°C
		Fast	10°C~45°C
	Discharge		-30°C~60°C
Storage		-20°C~60°C	
Internal Impedance(mΩ) (After Charge)		≤ 31	
Weight		16 g	

